

Voting Advice Applications

Causal Effects of VAA usage on
political preferences, vote choice and turnout

Presentation in the workshop
'Government and the Internet: Participation and Control'

Kristjan Vassil
European University Institute

March 8, 2011
Florence

Very short overview

Causal effects

**Eestis ei ole naiste ja meeste võrdõiguslikkusega selliseid
probleeme, mis nõuaks riigi sekkumist**

Eestis ei ole naiste ja meeste võrdõiguslikkusega selliseid
probleeme, mis nõuaks riigi sekkumist



Lähim erakond

Erakondade pingerida väljendab Sinu hoiakute kokkulangevust erakondade hoiakutega. Mida suurem protsent, seda suurem on nõustumine Sinu ja erakonna vahel.

Poliitiline radar

Maastik

Salvesta tulemus

Jaga tulemust



Lähim erakond

Lülita foor välja

Lülita kaalud välja



Foor reastab erakonnad selle järgi, millise erakonna poolt Sa oled valmis hääletama. Foori välja lülitades jäävad kattuvuse protsendid samaks. Muutub vaid erakondade järjestus, sest Sinu hinnangut vastava erakonna poolt hääletamise tõenäosusele kompass siis ei arvesta. Julgustame Sind foori välja lülitama ja süvenema ka nende erakondade positsioonidesse, kelle poolt hääletamist pead vähem tõenäoliseks, kuid kellega Su vaated väidetes sisalduvatele küsimustele on tegelikult lähedased.

Kaalusid sisse välja lülitades võivad kattuvuse protsendid muutuda, sest muutub väidete suhteline tähtsus seisukohtade kattuvuse arvutamisel.

Lähim erakond väljendab Sinu vastuste kokkulangevust erakondade positsioonidega protsentides. See on kõige täpsem viis, kuidas analüüsida Sinu ja erakonna arvamuste kattuvust, kuna arvesse võetakse kõik 30 poliitilist väidet.

Sul on võimalus enda tulemust vaadata ka Poliitilisel radaril ning Poliitilisel maastikul. Mõlemal juhul on tegemist illustreerivate diagrammidega, mis on erakondade pingereaga võrreldes vähemtäpsused, kuna ei sisalda kõiki 30 väidet. Poliitilisel maastikul orienteerumiseks võib nendest siiski abi olla.

orienteerumiseks võib nendest siiski abi olla.

orienteerumiseks võib nendest siiski abi olla. Mõlemal juhul on tegemist illustreerivate diagrammidega, mis on erakondade pingereaga võrreldes vähemtäpsused, kuna ei sisalda kõiki 30 väidet. Poliitilisel maastikul orienteerumiseks võib nendest siiski abi olla.

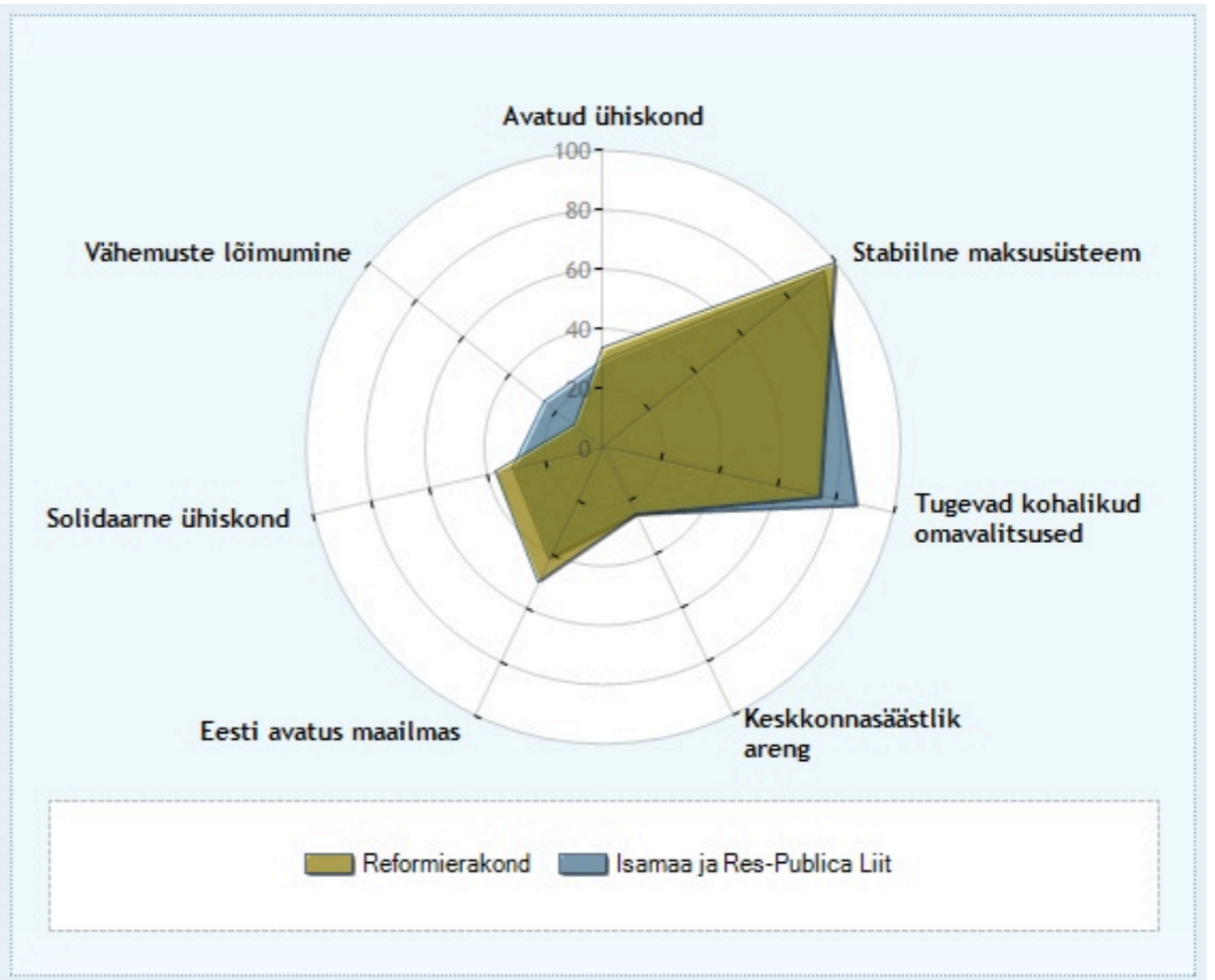
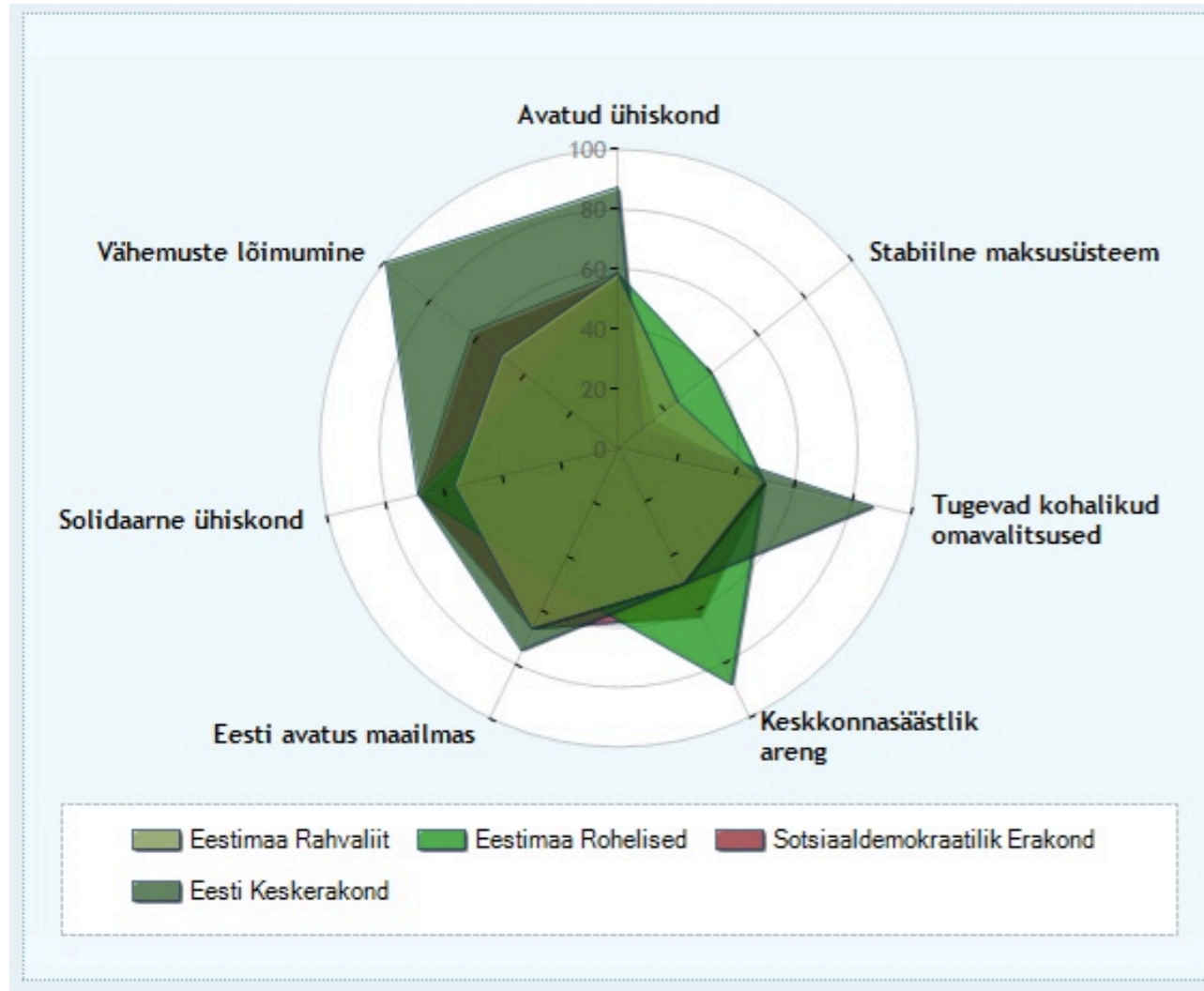

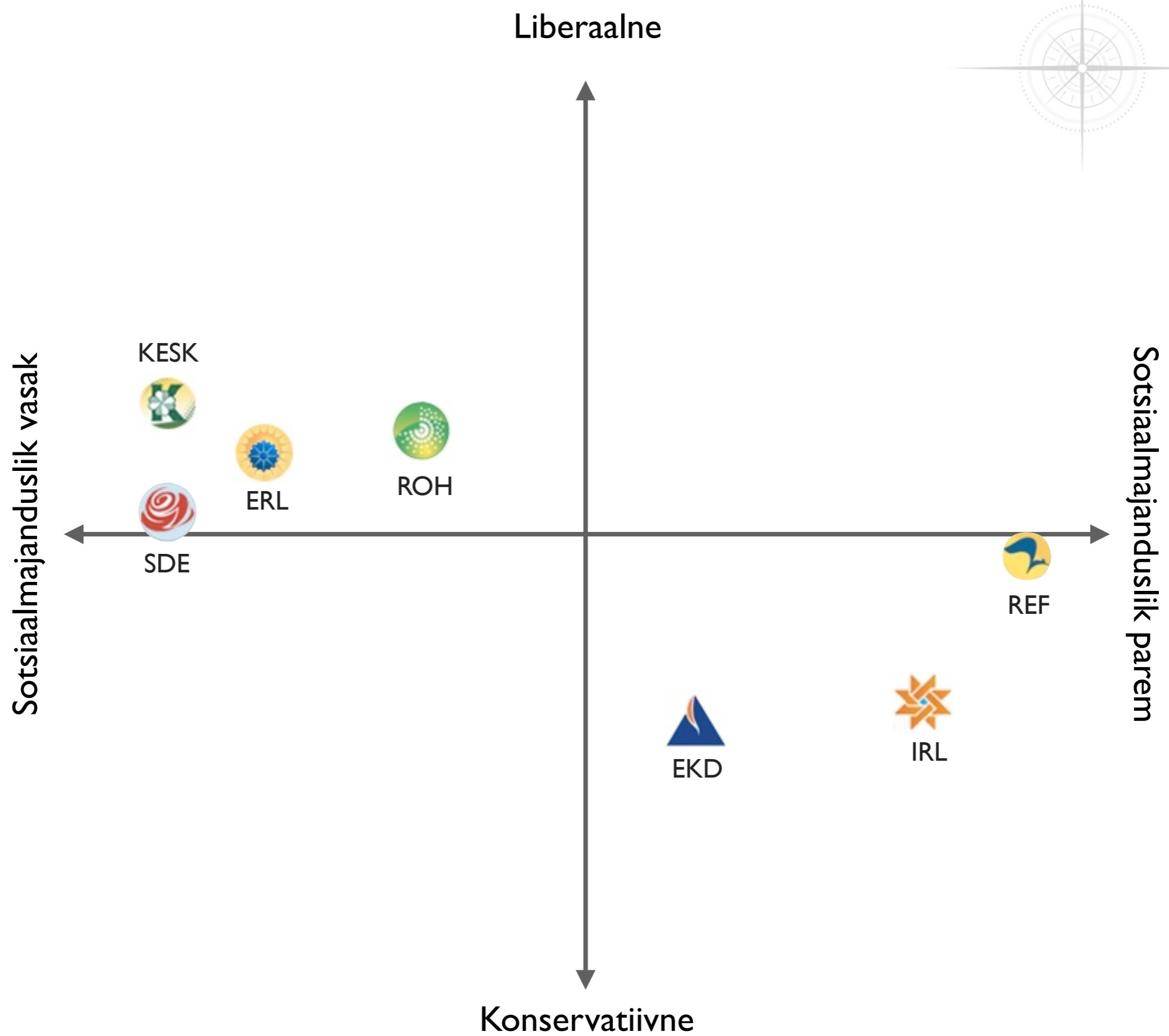

in just 6 weeks

in just 6 weeks

1 1 0 , 0 0 0

1 1 0 , 0 0 0

in just 6 weeks

110,000

10% of eligible voters

7000
6000
5000
4000
3000
2000
1000
0

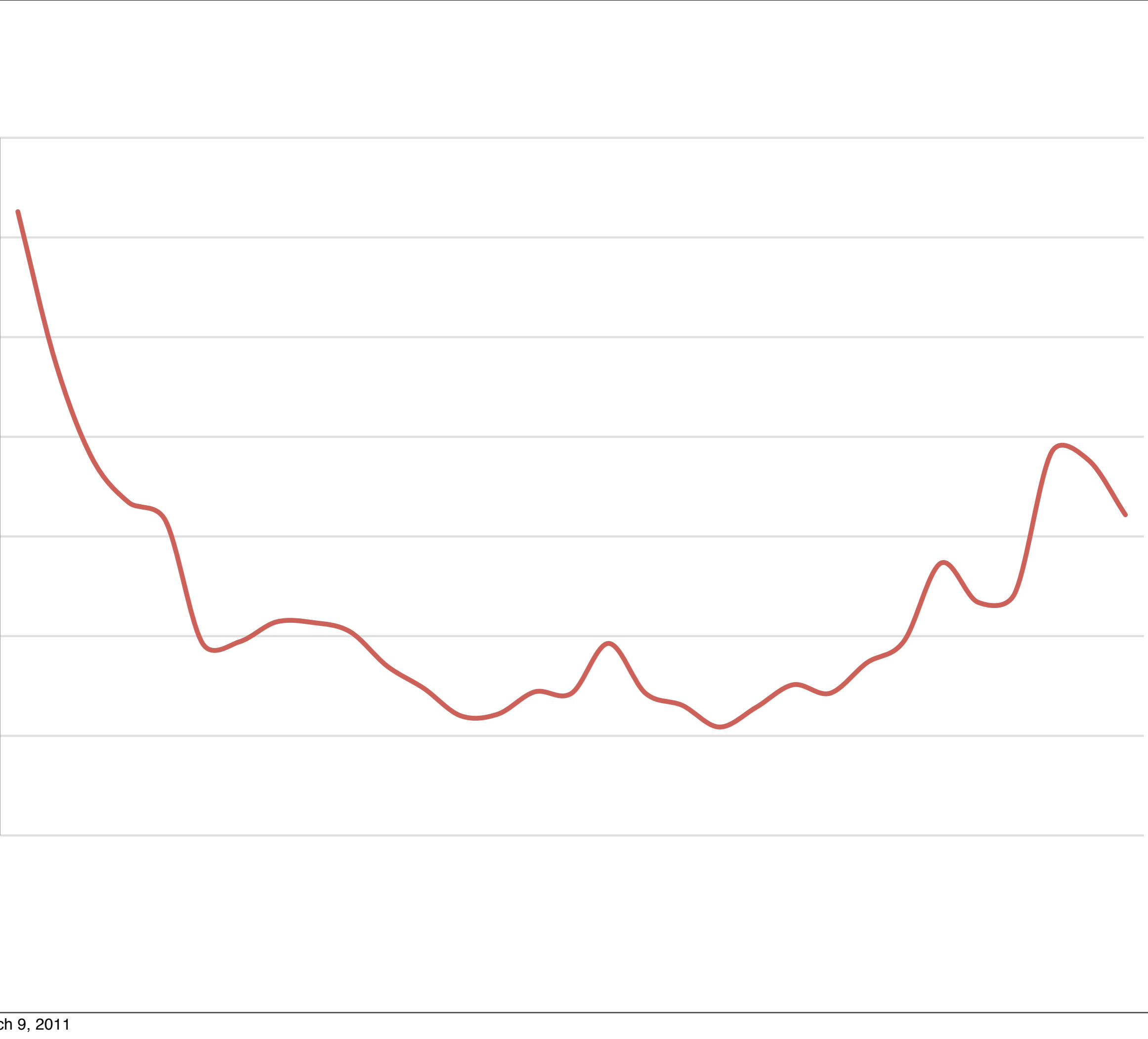

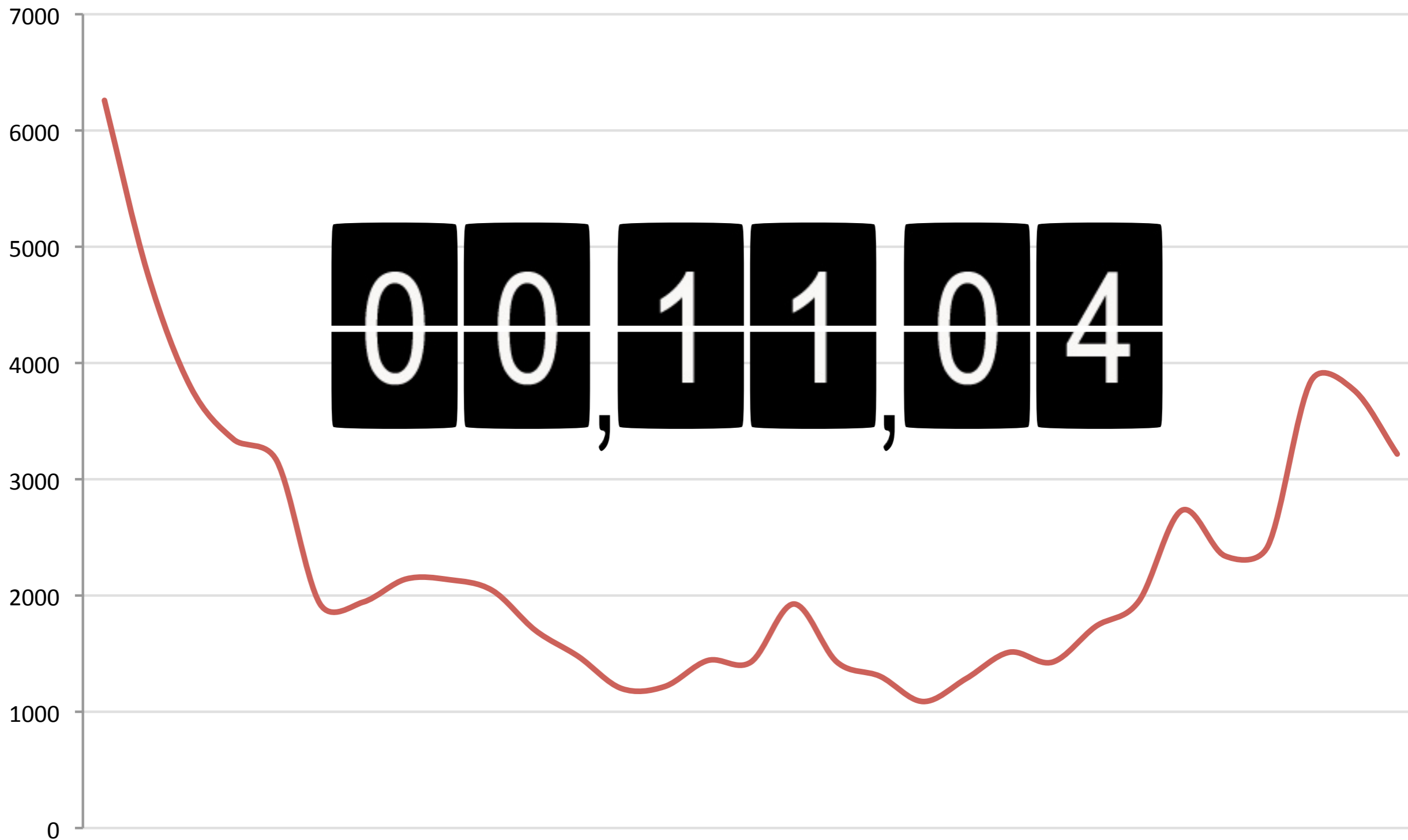

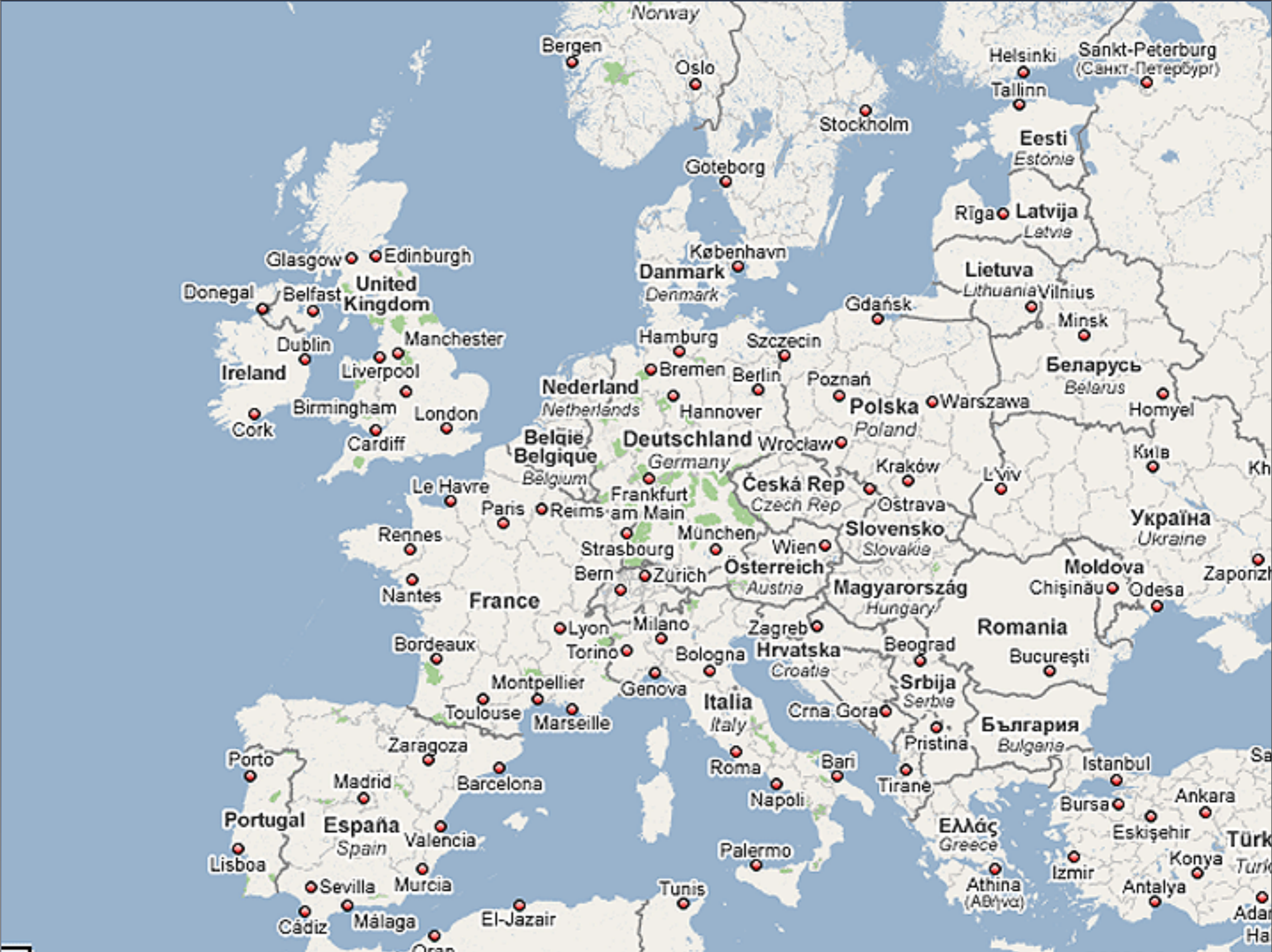

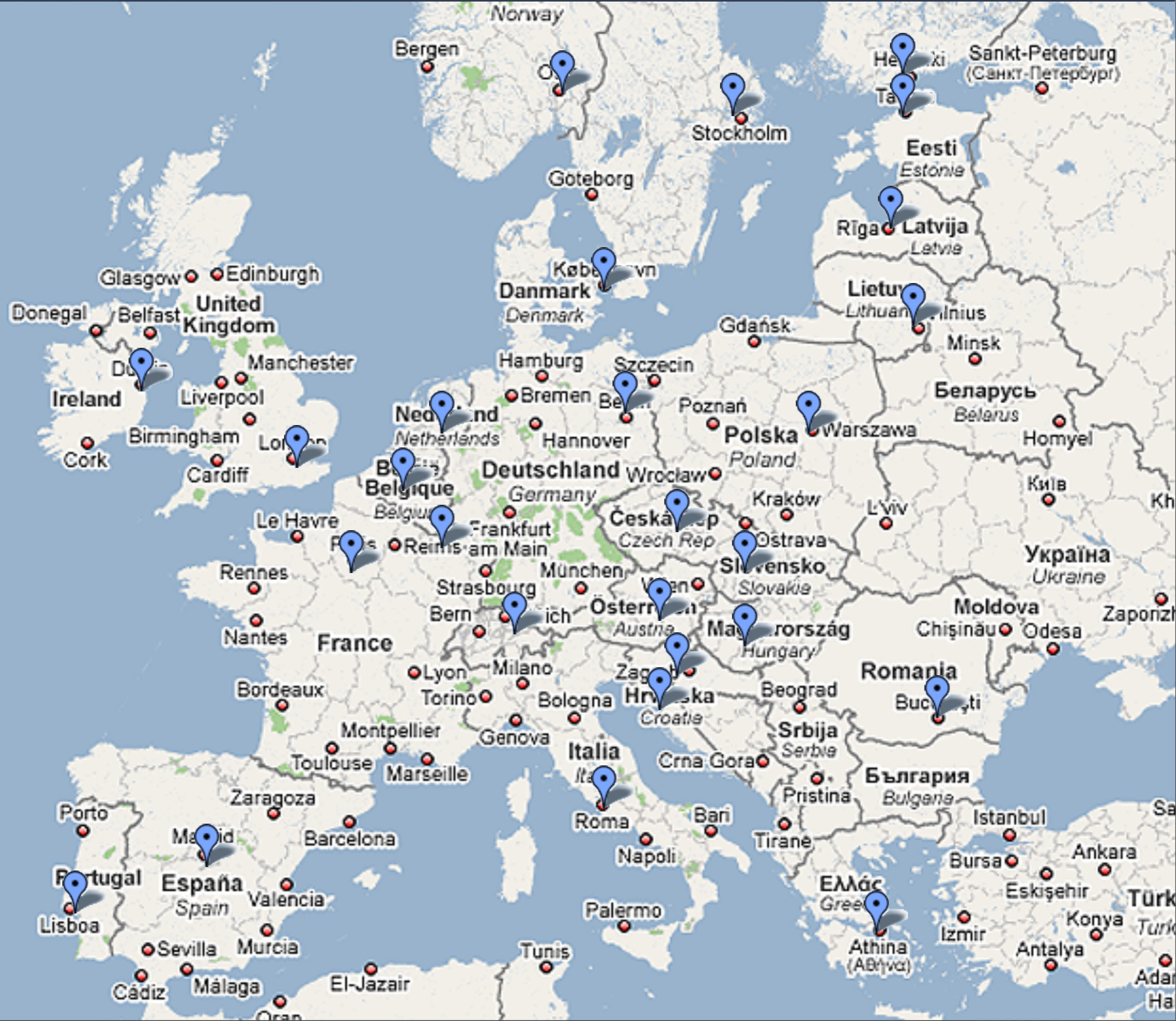



Advices issued

Advices issued

The Netherlands 2006 1.7 mil 14%

A map of Europe with several blue location pins. The pins are located in Norway (Bergen, Oslo), Sweden (Stockholm, Göteborg), Denmark (Copenhagen), Estonia (Tallinn), Latvia (Riga), Lithuania (Vilnius), and the United Kingdom (Glasgow, Edinburgh).

Advices issued

The Netherlands	2006	1.7 mil	14%
Switzerland	2007	1 mil	22%



A map of Europe with several blue location pins placed over various countries. The pins are located in Norway (Bergen, Oslo), Sweden (Stockholm, Göteborg), Denmark (Copenhagen), Estonia (Tallinn), Latvia (Riga), Lithuania (Vilnius), and Greece (Athina).

Advices issued

The Netherlands	2006	1.7 mil	14%
-----------------	------	---------	-----

Switzerland	2007	1 mil	22%
-------------	------	-------	-----

Germany	2009	6.7 mil	11%
---------	------	---------	-----



Advices issued

The Netherlands	2006	1.7 mil	14%
Switzerland	2007	1 mil	22%
Germany	2009	6.7 mil	11%
Estonia	2011	0.1 mil	10%

Effects

eu★profiler

Leia enda asukoht poliitilisel maastikul 2009. aasta Euroopa Parlamendi valimiste kontekstis

Vali riik: Eesti Vabariik

Vali keel: eesti English

Start



Kieskompas.nl



★ help our research



nccr democracy

Advancing
Trouw



Election Day
June 7, 2009

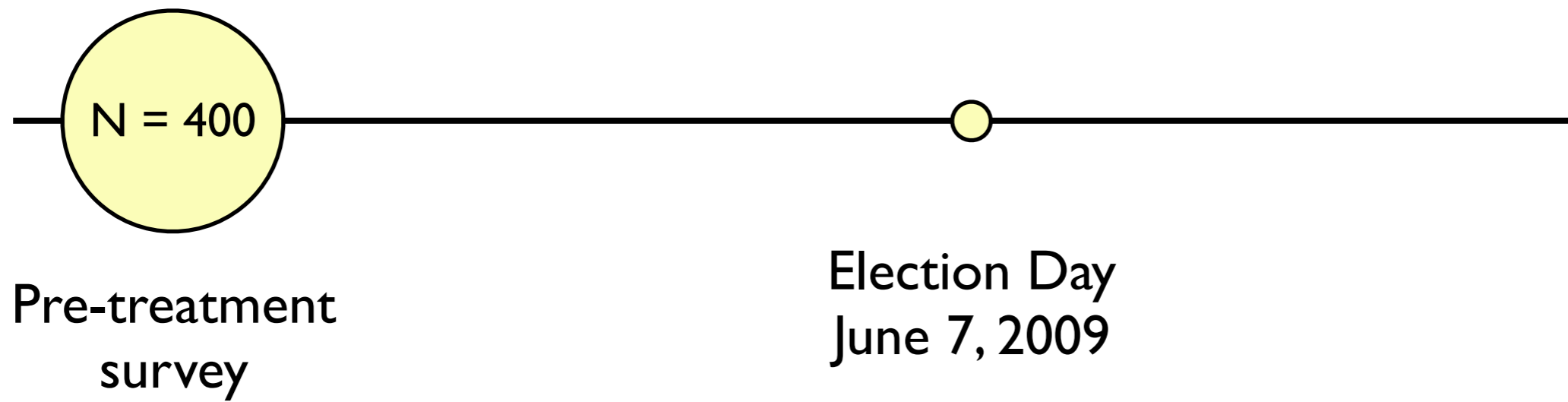

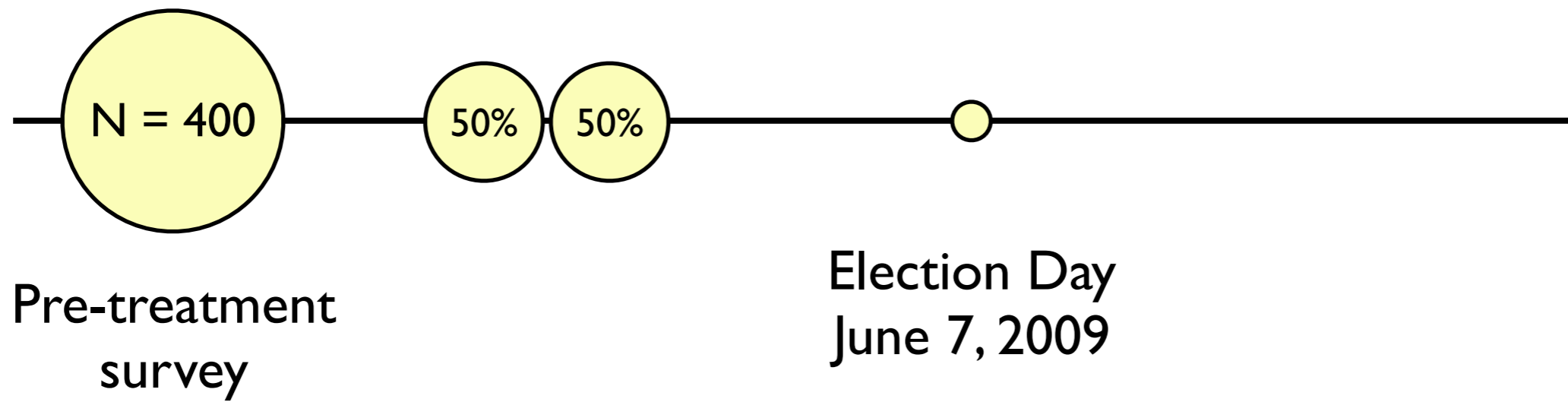

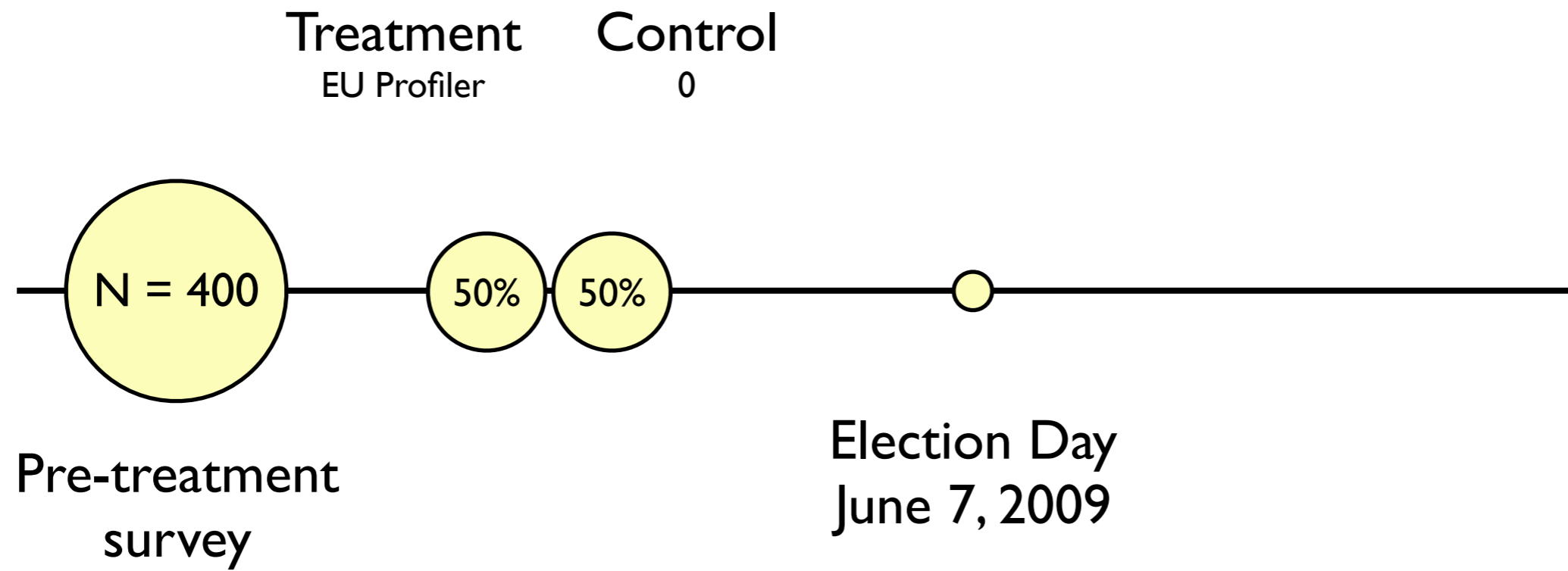

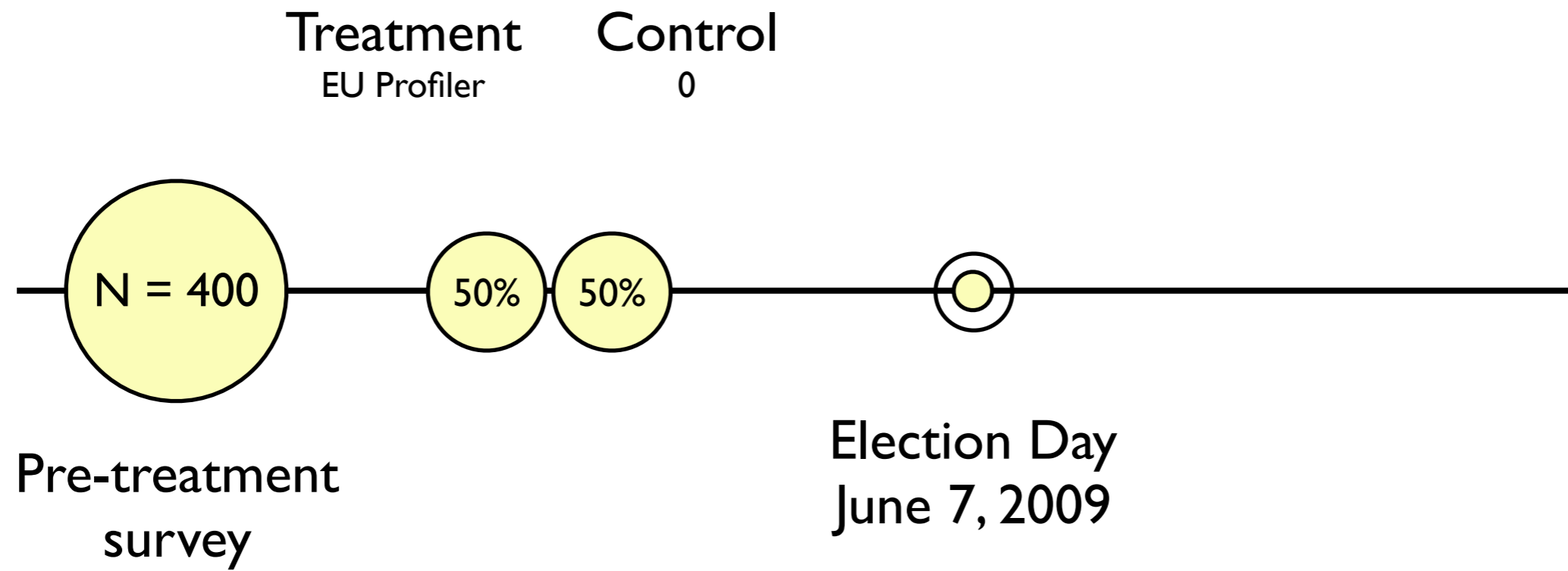

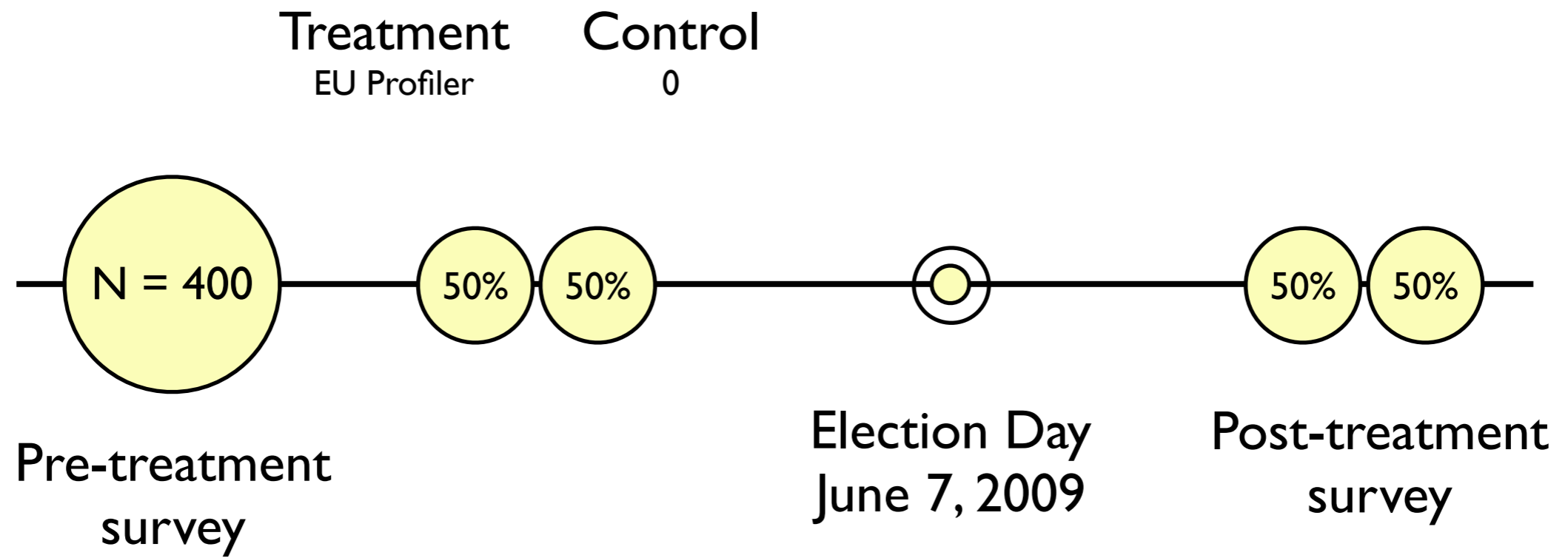

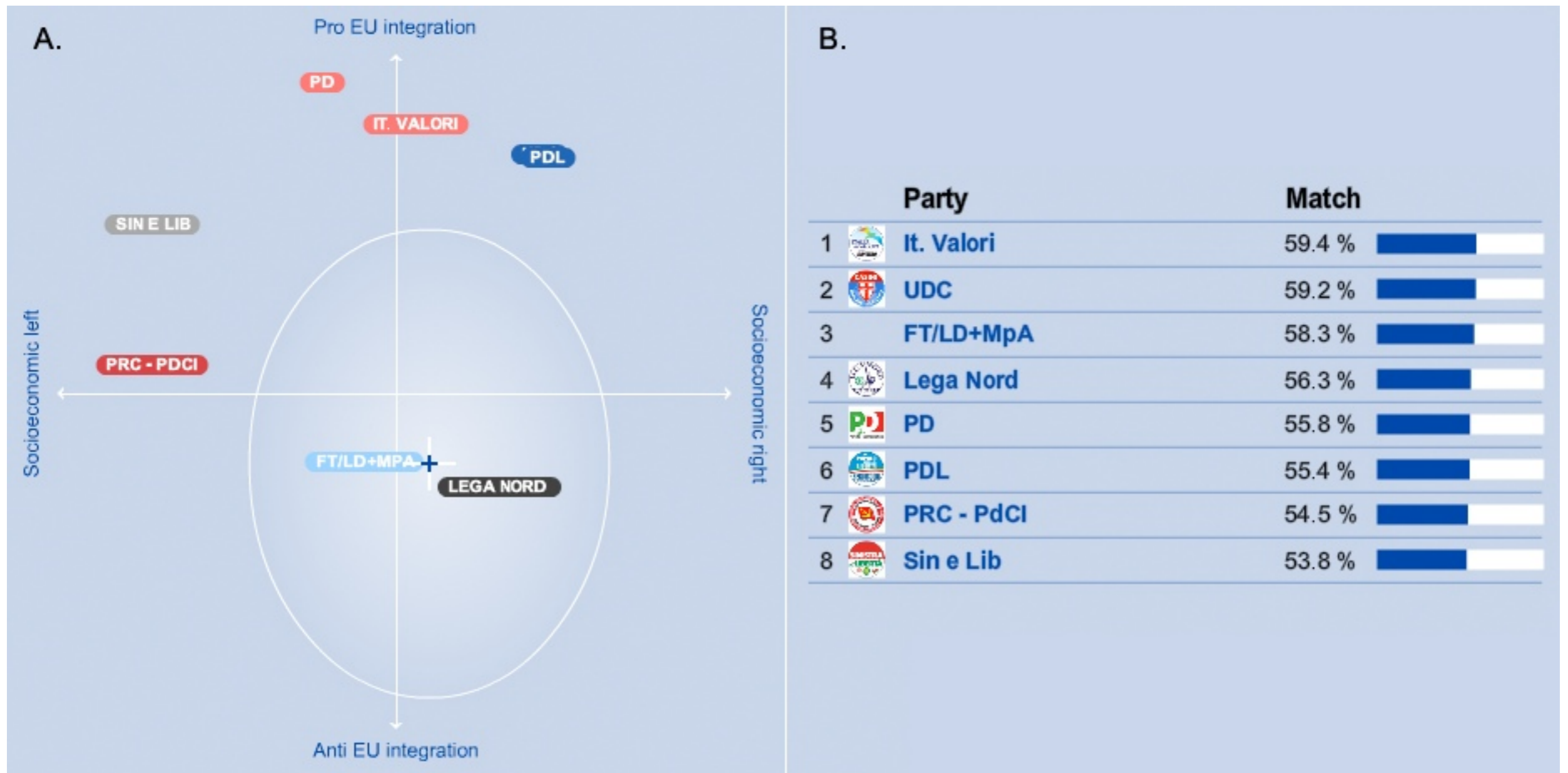

operationalization of:

political preferences

vote choice

turnout

Erakonnad

Jätka

Eestis on mitmeid erakondi kes sooviksid Teie häält. Kui tõenäoline see on, et Te kunagi annate oma hääle järgnevatele erakondadele? Märkige oma eelistus skaalal 0 - 10, kus 0 tähendab "ei ole üldse tõenäoline" ning 10 tähendab "väga tõenäoline".

	0	1	2	3	4	5	6	7	8	9	10
Eesti Keskerakond	<input checked="" type="radio"/>	<input type="radio"/>	<input type="radio"/>	<input type="radio"/>	<input type="radio"/>	<input type="radio"/>	<input type="radio"/>	<input type="radio"/>	<input type="radio"/>	<input type="radio"/>	<input type="radio"/>
Reformierakond	<input type="radio"/>	<input type="radio"/>	<input type="radio"/>	<input type="radio"/>	<input type="radio"/>	<input checked="" type="radio"/>	<input type="radio"/>	<input type="radio"/>	<input type="radio"/>	<input type="radio"/>	<input type="radio"/>
Eestimaa Rohelised	<input type="radio"/>	<input type="radio"/>	<input type="radio"/>	<input type="radio"/>	<input checked="" type="radio"/>	<input type="radio"/>	<input type="radio"/>	<input type="radio"/>	<input type="radio"/>	<input type="radio"/>	<input type="radio"/>
Isamaa ja Res-Publica Liit	<input type="radio"/>	<input type="radio"/>	<input type="radio"/>	<input type="radio"/>	<input type="radio"/>	<input type="radio"/>	<input type="radio"/>	<input type="radio"/>	<input checked="" type="radio"/>	<input type="radio"/>	<input type="radio"/>
Sotsiaaldemokraatlik Erakond	<input type="radio"/>	<input type="radio"/>	<input type="radio"/>	<input type="radio"/>	<input type="radio"/>	<input type="radio"/>	<input type="radio"/>	<input type="radio"/>	<input type="radio"/>	<input checked="" type="radio"/>	<input type="radio"/>
Eestimaa Rahvaliit	<input type="radio"/>	<input checked="" type="radio"/>	<input type="radio"/>	<input type="radio"/>	<input type="radio"/>	<input type="radio"/>	<input type="radio"/>	<input type="radio"/>	<input type="radio"/>	<input type="radio"/>	<input type="radio"/>

Erakonnad

Jätka

Eestis on mitmeid erakondi kes sooviksid Teie häält. Kui tõenäoline see on, et Te kunagi annate oma hääle järgnevatele erakondadele? Märkige oma eelistus skaalal 0 - 10, kus 0 tähendab "ei ole üldse tõenäoline" ning 10 tähendab "väga tõenäoline".

	0	1	2	3	4	5	6	7	8	9	10
Eesti Keskerakond	<input checked="" type="radio"/>	<input type="radio"/>	<input type="radio"/>	<input type="radio"/>	<input type="radio"/>	<input type="radio"/>	<input type="radio"/>	<input type="radio"/>	<input type="radio"/>	<input type="radio"/>	<input type="radio"/>
Reformierakond	<input type="radio"/>	<input type="radio"/>	<input type="radio"/>	<input type="radio"/>	<input type="radio"/>	<input checked="" type="radio"/>	<input type="radio"/>	<input type="radio"/>	<input type="radio"/>	<input type="radio"/>	<input type="radio"/>
Eestimaa Rohelised	<input type="radio"/>	<input type="radio"/>	<input type="radio"/>	<input type="radio"/>	<input checked="" type="radio"/>	<input type="radio"/>	<input type="radio"/>	<input type="radio"/>	<input type="radio"/>	<input type="radio"/>	<input type="radio"/>
Isamaa ja Res-Publica Liit	<input type="radio"/>	<input type="radio"/>	<input type="radio"/>	<input type="radio"/>	<input type="radio"/>	<input type="radio"/>	<input type="radio"/>	<input checked="" type="radio"/>	<input type="radio"/>	<input type="radio"/>	<input type="radio"/>
Sotsiaaldemokraatlik Erakond	<input type="radio"/>	<input type="radio"/>	<input type="radio"/>	<input type="radio"/>	<input type="radio"/>	<input type="radio"/>	<input type="radio"/>	<input type="radio"/>	<input checked="" type="radio"/>	<input type="radio"/>	<input type="radio"/>
Eestimaa Rahvaliid	<input type="radio"/>	<input checked="" type="radio"/>	<input type="radio"/>	<input type="radio"/>	<input type="radio"/>	<input type="radio"/>	<input type="radio"/>	<input type="radio"/>	<input type="radio"/>	<input type="radio"/>	<input type="radio"/>

Erakonnad

Jätka

Eestis on mitmeid erakondi kes sooviksid Teie häält. Kui tõenäoline see on, et Te kunagi annate oma hääle järgnevatele erakondadele? Märkige oma eelistus skaalal 0 - 10, kus 0 tähendab "ei ole üldse tõenäoline" ning 10 tähendab "väga tõenäoline".

	0	1	2	3	4	5	6	7	8	9	10
Eesti Keskerakond	<input checked="" type="radio"/>	<input type="radio"/>	<input type="radio"/>	<input type="radio"/>	<input type="radio"/>	<input type="radio"/>	<input type="radio"/>	<input type="radio"/>	<input type="radio"/>	<input type="radio"/>	<input type="radio"/>
Reformierakond	<input type="radio"/>	<input type="radio"/>	<input type="radio"/>	<input type="radio"/>	<input type="radio"/>	<input checked="" type="radio"/>	<input type="radio"/>	<input type="radio"/>	<input type="radio"/>	<input type="radio"/>	<input type="radio"/>
Eestimaa Rohelised	<input type="radio"/>	<input type="radio"/>	<input type="radio"/>	<input type="radio"/>	<input checked="" type="radio"/>	<input type="radio"/>	<input type="radio"/>	<input type="radio"/>	<input type="radio"/>	<input type="radio"/>	<input type="radio"/>
Isamaa ja Res-Publica Liit	<input type="radio"/>	<input type="radio"/>	<input type="radio"/>	<input type="radio"/>	<input type="radio"/>	<input type="radio"/>	<input type="radio"/>	<input checked="" type="radio"/>	<input type="radio"/>	<input type="radio"/>	<input type="radio"/>
Sotsiaaldemokraatlik Erakond	<input type="radio"/>	<input type="radio"/>	<input type="radio"/>	<input type="radio"/>	<input type="radio"/>	<input type="radio"/>	<input type="radio"/>	<input type="radio"/>	<input checked="" type="radio"/>	<input type="radio"/>	<input type="radio"/>
Eestimaa Rahvaliid	<input type="radio"/>	<input checked="" type="radio"/>	<input type="radio"/>	<input type="radio"/>	<input type="radio"/>	<input type="radio"/>	<input type="radio"/>	<input type="radio"/>	<input type="radio"/>	<input type="radio"/>	<input type="radio"/>

t

Erakonnad

Jätka

Eestis on mitmeid erakondi kes sooviksid Teie häält. Kui tõenäoline see on, et Te kunagi annate oma hääle järgnevatele erakondadele? Märkige oma eelistus skaalal 0 - 10, kus 0 tähendab "ei ole üldse tõenäoline" ning 10 tähendab "väga tõenäoline".

	0	1	2	3	4	5	6	7	8	9	10
Eesti Keskerakond	<input checked="" type="radio"/>	<input type="radio"/>	<input type="radio"/>	<input type="radio"/>	<input type="radio"/>	<input type="radio"/>	<input type="radio"/>	<input type="radio"/>	<input type="radio"/>	<input type="radio"/>	<input type="radio"/>
Reformierakond	<input type="radio"/>	<input type="radio"/>	<input type="radio"/>	<input type="radio"/>	<input type="radio"/>	<input checked="" type="radio"/>	<input type="radio"/>	<input type="radio"/>	<input type="radio"/>	<input type="radio"/>	<input type="radio"/>
Eestimaa Rohelised	<input type="radio"/>	<input type="radio"/>	<input type="radio"/>	<input type="radio"/>	<input checked="" type="radio"/>	<input type="radio"/>	<input type="radio"/>	<input type="radio"/>	<input type="radio"/>	<input type="radio"/>	<input type="radio"/>
Isamaa ja Res-Publica Liit	<input type="radio"/>	<input type="radio"/>	<input type="radio"/>	<input type="radio"/>	<input type="radio"/>	<input type="radio"/>	<input type="radio"/>	<input checked="" type="radio"/>	<input type="radio"/>	<input type="radio"/>	<input type="radio"/>
Sotsiaaldemokraatlik Erakond	<input type="radio"/>	<input type="radio"/>	<input type="radio"/>	<input type="radio"/>	<input type="radio"/>	<input type="radio"/>	<input type="radio"/>	<input type="radio"/>	<input checked="" type="radio"/>	<input type="radio"/>	<input type="radio"/>
Eestimaa Rahvaliit	<input type="radio"/>	<input checked="" type="radio"/>	<input type="radio"/>	<input type="radio"/>	<input type="radio"/>	<input type="radio"/>	<input type="radio"/>	<input type="radio"/>	<input type="radio"/>	<input type="radio"/>	<input type="radio"/>

Erakonnad

Jätka

Eestis on mitmeid erakondi kes sooviksid Teie häält. Kui tõenäoline see on, et Te kunagi annate oma hääle järgnevatele erakondadele? Märkige oma eelistus skaalal 0 - 10, kus 0 tähendab "ei ole üldse tõenäoline" ning 10 tähendab "väga tõenäoline".

	0	1	2	3	4	5	6	7	8	9	10
Eesti Keskerakond	<input checked="" type="radio"/>	<input type="radio"/>	<input type="radio"/>	<input type="radio"/>	<input type="radio"/>	<input type="radio"/>	<input type="radio"/>	<input type="radio"/>	<input type="radio"/>	<input type="radio"/>	<input type="radio"/>
Reformierakond	<input type="radio"/>	<input type="radio"/>	<input type="radio"/>	<input type="radio"/>	<input type="radio"/>	<input checked="" type="radio"/>	<input type="radio"/>	<input type="radio"/>	<input type="radio"/>	<input type="radio"/>	<input type="radio"/>
Eestimaa Rohelised	<input type="radio"/>	<input type="radio"/>	<input type="radio"/>	<input type="radio"/>	<input checked="" type="radio"/>	<input type="radio"/>	<input type="radio"/>	<input type="radio"/>	<input type="radio"/>	<input type="radio"/>	<input type="radio"/>
Isamaa ja Res-Publica Liit	<input type="radio"/>	<input type="radio"/>	<input type="radio"/>	<input type="radio"/>	<input type="radio"/>	<input type="radio"/>	<input type="radio"/>	<input checked="" type="radio"/>	<input type="radio"/>	<input type="radio"/>	<input type="radio"/>
Sotsiaaldemokraatlik Erakond	<input type="radio"/>	<input type="radio"/>	<input type="radio"/>	<input type="radio"/>	<input type="radio"/>	<input type="radio"/>	<input type="radio"/>	<input type="radio"/>	<input checked="" type="radio"/>	<input type="radio"/>	<input type="radio"/>
Eestimaa Rahvaliit	<input type="radio"/>	<input checked="" type="radio"/>	<input type="radio"/>	<input type="radio"/>	<input type="radio"/>	<input type="radio"/>	<input type="radio"/>	<input type="radio"/>	<input type="radio"/>	<input type="radio"/>	<input type="radio"/>

t

Erakonnad

Eestis on mitmeid erakondi kes sooviksid Teie häält. Kui tõenäoline see on, et Te kunagi annate oma hääle järgnevatele erakondadele? Märkige oma eelistus skaalal 0 - 10, kus 0 tähendab "ei ole üldse tõenäoline" ning 10 tähendab "väga tõenäoline".

Jätka

	0	1	2	3	4	5	6	7	8	9	10
Eesti Keskerakond	<input checked="" type="radio"/>	<input type="radio"/>	<input type="radio"/>	<input type="radio"/>	<input type="radio"/>	<input type="radio"/>	<input type="radio"/>	<input type="radio"/>	<input type="radio"/>	<input type="radio"/>	<input type="radio"/>
Reformierakond	<input type="radio"/>	<input type="radio"/>	<input type="radio"/>	<input type="radio"/>	<input type="radio"/>	<input checked="" type="radio"/>	<input type="radio"/>	<input type="radio"/>	<input type="radio"/>	<input type="radio"/>	<input type="radio"/>
Eestimaa Rohelised	<input type="radio"/>	<input type="radio"/>	<input type="radio"/>	<input type="radio"/>	<input checked="" type="radio"/>	<input type="radio"/>	<input type="radio"/>	<input type="radio"/>	<input type="radio"/>	<input type="radio"/>	<input type="radio"/>
Isamaa ja Res-Publica Liit	<input type="radio"/>	<input type="radio"/>	<input type="radio"/>	<input type="radio"/>	<input type="radio"/>	<input type="radio"/>	<input type="radio"/>	<input checked="" type="radio"/>	<input type="radio"/>	<input type="radio"/>	<input type="radio"/>
Sotsiaaldemokraatlik Erakond	<input type="radio"/>	<input type="radio"/>	<input type="radio"/>	<input type="radio"/>	<input type="radio"/>	<input type="radio"/>	<input type="radio"/>	<input type="radio"/>	<input checked="" type="radio"/>	<input type="radio"/>	<input type="radio"/>
Eestimaa Rahvaliid	<input type="radio"/>	<input checked="" type="radio"/>	<input type="radio"/>	<input type="radio"/>	<input type="radio"/>	<input type="radio"/>	<input type="radio"/>	<input type="radio"/>	<input type="radio"/>	<input type="radio"/>	<input type="radio"/>

t-1

Erakonnad

Eestis on mitmeid erakondi kes sooviksid Teie häält. Kui tõenäoline see on, et Te kunagi annate oma hääle järgnevatele erakondadele? Märkige oma eelistus skaalal 0 - 10, kus 0 tähendab "ei ole üldse tõenäoline" ning 10 tähendab "väga tõenäoline".

Jätka

	0	1	2	3	4	5	6	7	8	9	10
Eesti Keskerakond	<input checked="" type="radio"/>	<input type="radio"/>	<input type="radio"/>	<input type="radio"/>	<input type="radio"/>	<input type="radio"/>	<input type="radio"/>	<input type="radio"/>	<input type="radio"/>	<input type="radio"/>	<input type="radio"/>
Reformierakond	<input type="radio"/>	<input type="radio"/>	<input type="radio"/>	<input type="radio"/>	<input type="radio"/>	<input checked="" type="radio"/>	<input type="radio"/>	<input type="radio"/>	<input type="radio"/>	<input type="radio"/>	<input type="radio"/>
Eestimaa Rohelised	<input type="radio"/>	<input type="radio"/>	<input type="radio"/>	<input type="radio"/>	<input checked="" type="radio"/>	<input type="radio"/>	<input type="radio"/>	<input type="radio"/>	<input type="radio"/>	<input type="radio"/>	<input type="radio"/>
Isamaa ja Res-Publica Liit	<input type="radio"/>	<input type="radio"/>	<input type="radio"/>	<input type="radio"/>	<input type="radio"/>	<input type="radio"/>	<input type="radio"/>	<input checked="" type="radio"/>	<input type="radio"/>	<input type="radio"/>	<input type="radio"/>
Sotsiaaldemokraatlik Erakond	<input type="radio"/>	<input type="radio"/>	<input type="radio"/>	<input type="radio"/>	<input type="radio"/>	<input type="radio"/>	<input type="radio"/>	<input type="radio"/>	<input checked="" type="radio"/>	<input type="radio"/>	<input type="radio"/>
Eestimaa Rahvaliid	<input type="radio"/>	<input checked="" type="radio"/>	<input type="radio"/>	<input type="radio"/>	<input type="radio"/>	<input type="radio"/>	<input type="radio"/>	<input type="radio"/>	<input type="radio"/>	<input type="radio"/>	<input type="radio"/>

		$Diff_t = PTV\ 1^{st} - PTV\ 2^{nd}$											
													
t	{	Party A	0	1	2	3	4	5	6	7	8	9	10
		Party B	0	1	2	3	4	5	6	7	8	9	10
		Party C	0	1	2	3	4	5	6	7	8	9	10

$$Diff_t = PTV\ 1^{st} - PTV\ 2^{nd}$$

t	{	Party A	0	1	2	3	4	5	6	7	8	9	10
		Party B	0	1	2	3	4	5	6	7	8	9	10
		Party C	0	1	2	3	4	5	6	7	8	9	10

$$Diff_{t-1} = PTV\ 1^{st} - PTV\ 2^{nd}$$

$t-1$	{	Party A	0	1	2	3	4	5	6	7	8	9	10
		Party B	0	1	2	3	4	5	6	7	8	9	10
		Party C	0	1	2	3	4	5	6	7	8	9	10

$$Diff_t = PTV\ 1^{st} - PTV\ 2^{nd}$$

t	{	Party A	0	1	2	3	4	5	6	7	8	9	10
		Party B	0	1	2	3	4	5	6	7	8	9	10
		Party C	0	1	2	3	4	5	6	7	8	9	10

$$Diff_{t-1} = PTV\ 1^{st} - PTV\ 2^{nd}$$

$t-1$	{	Party A	0	1	2	3	4	5	6	7	8	9	10
		Party B	0	1	2	3	4	5	6	7	8	9	10
		Party C	0	1	2	3	4	5	6	7	8	9	10

$$Y = Diff_t - Diff_{t-1}$$

vote choice



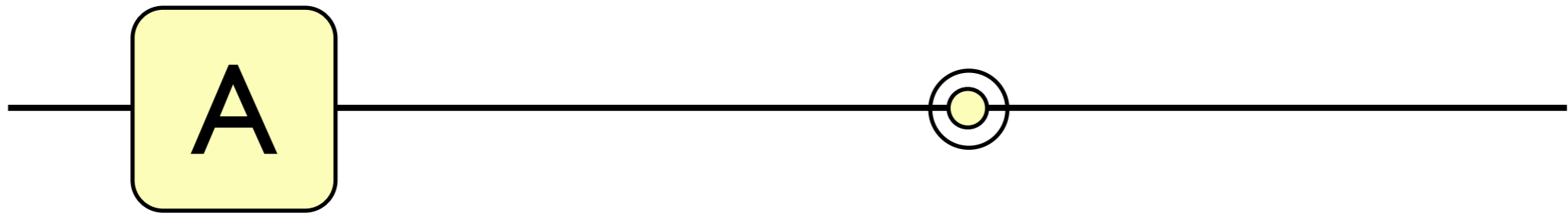

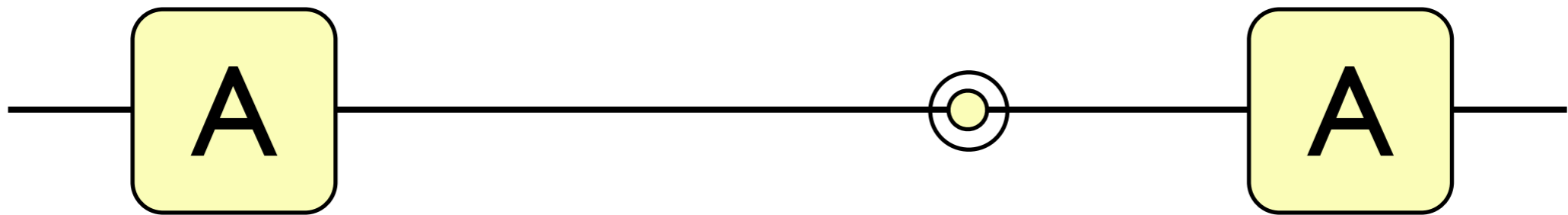

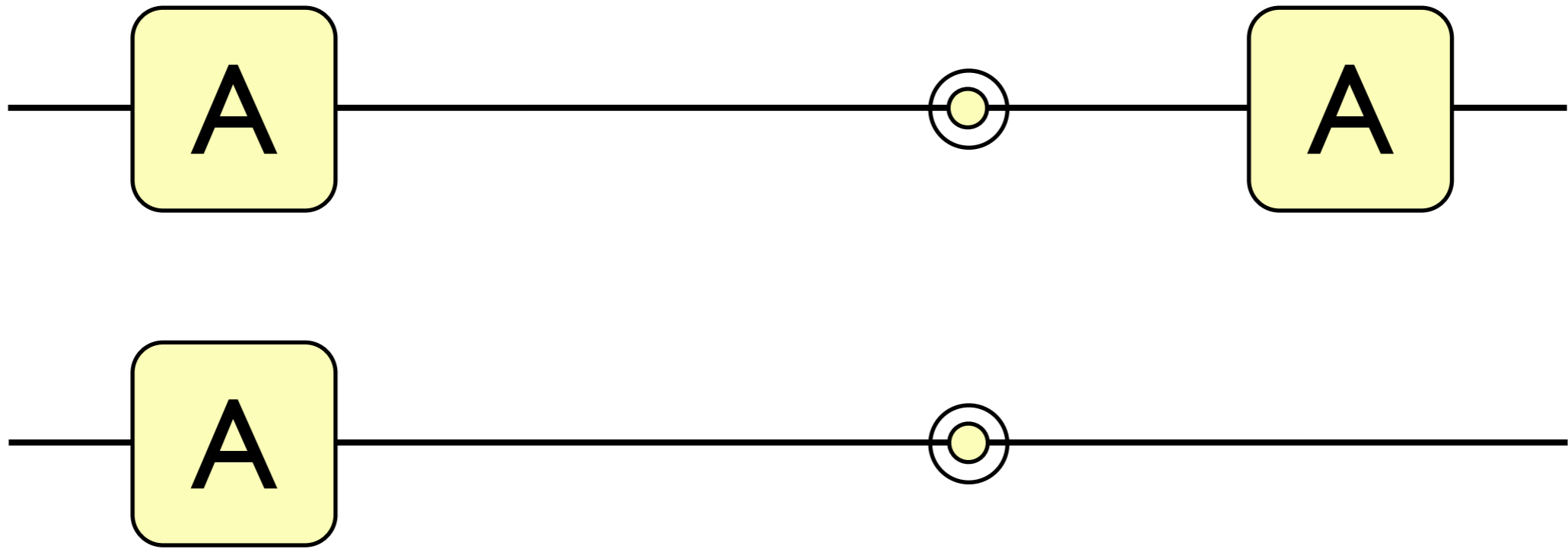

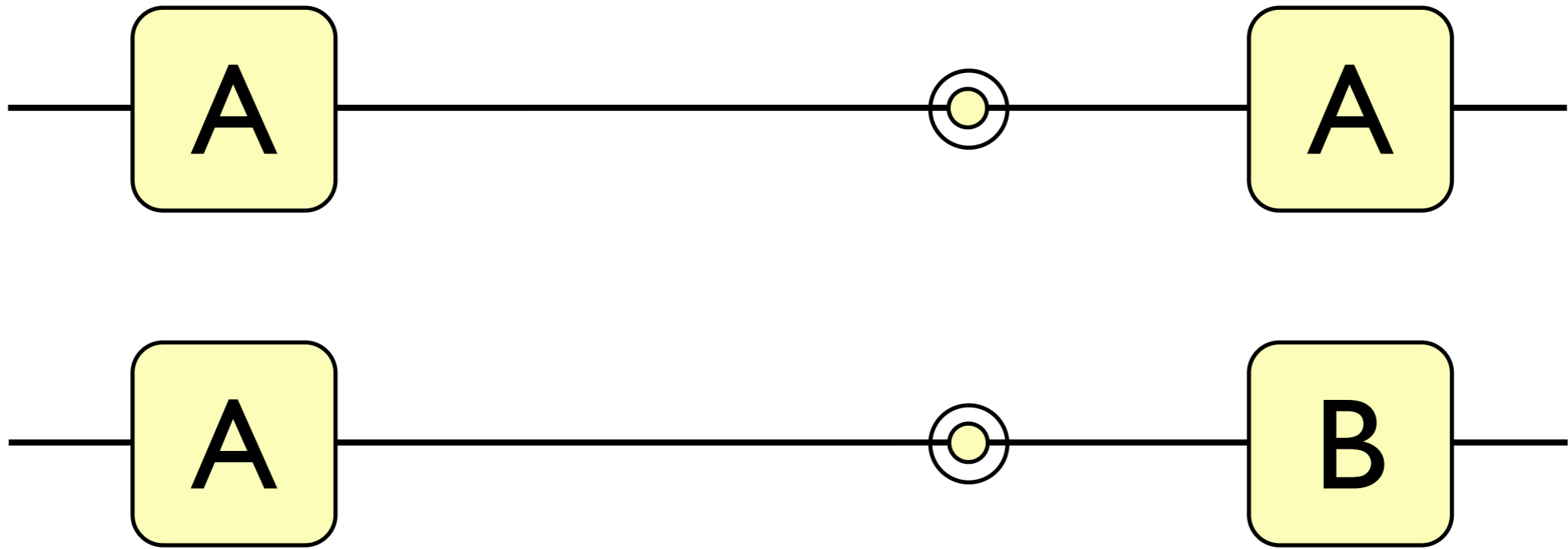

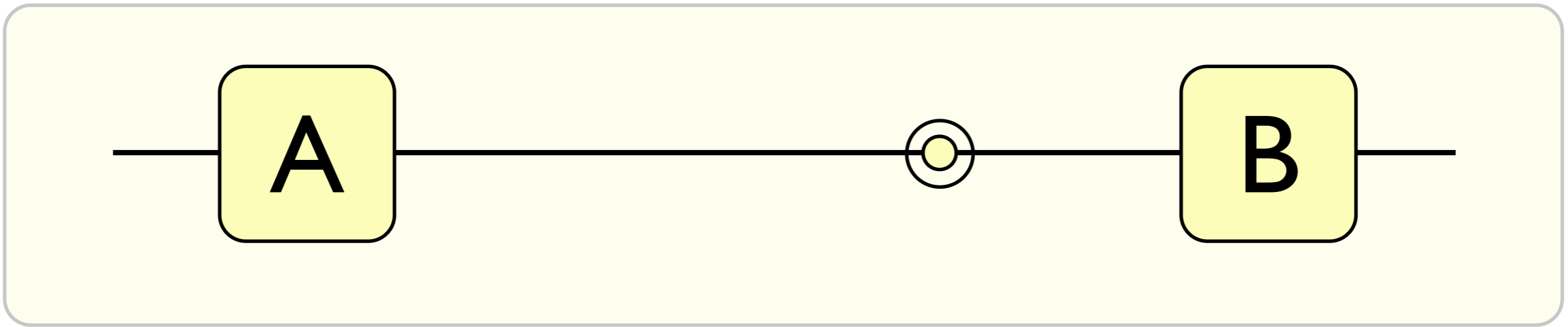
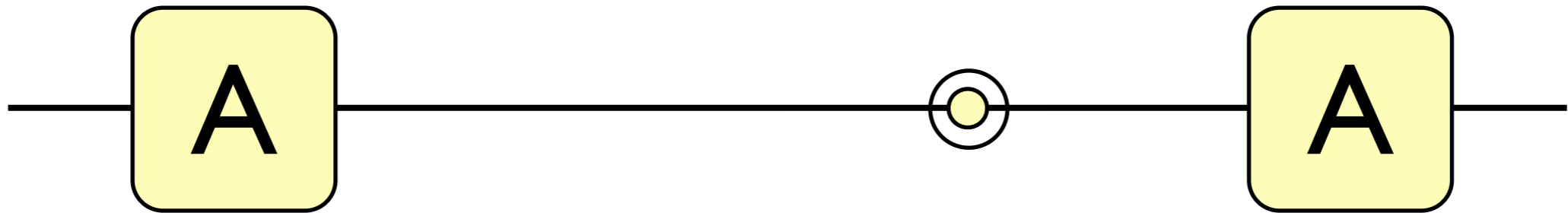

turnout / mobilization

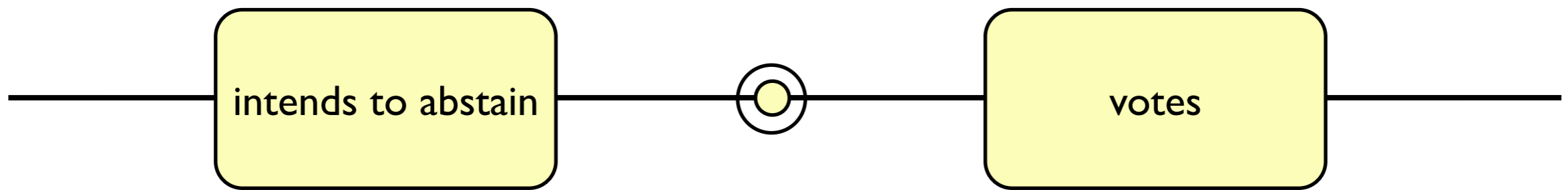

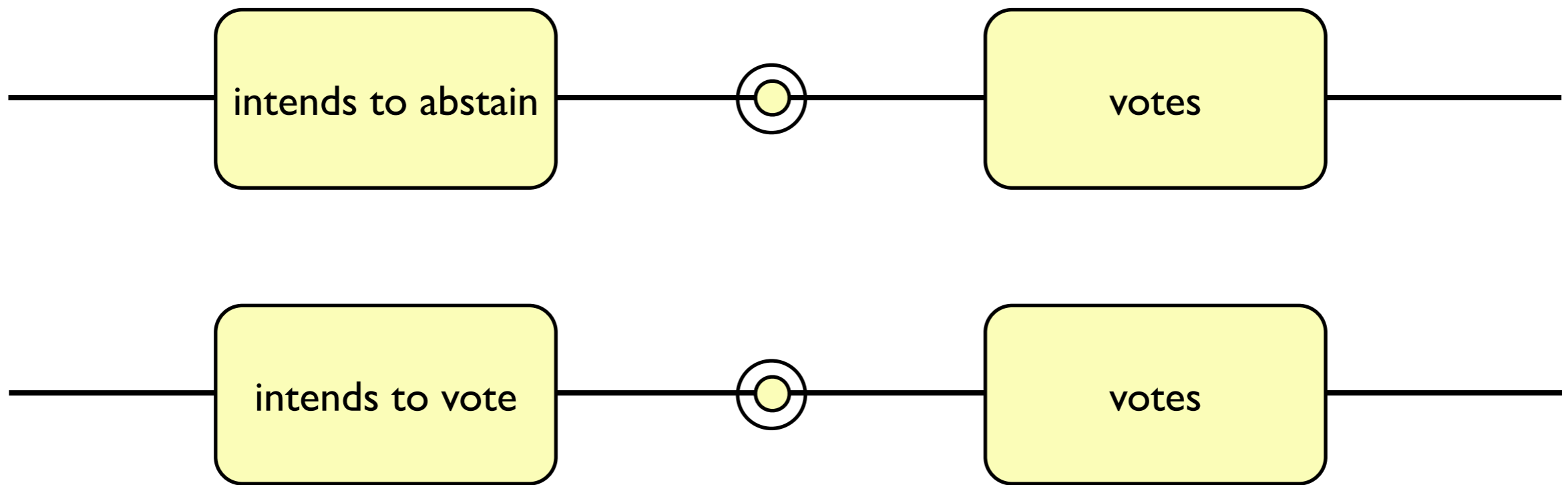

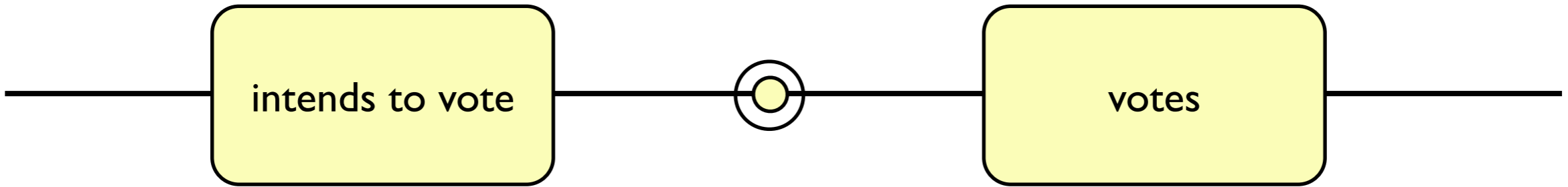
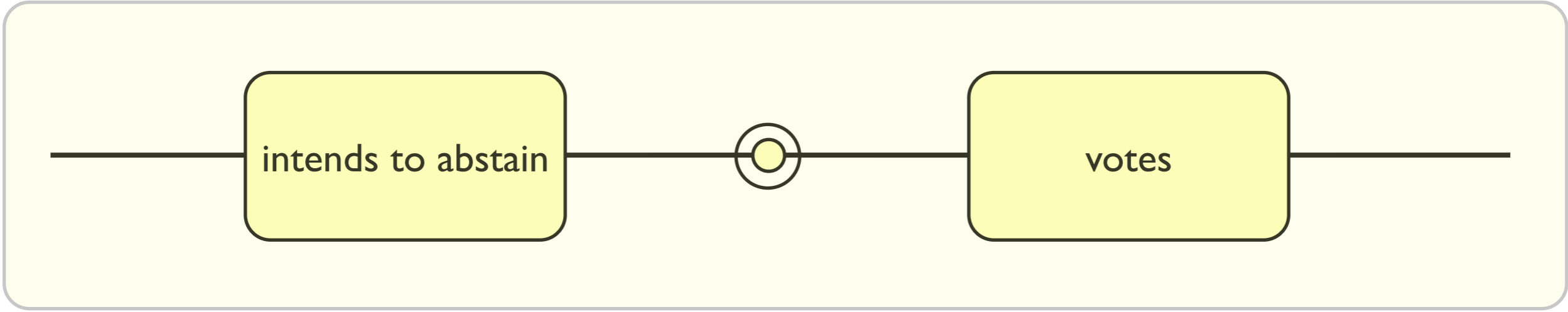

causal effect on:

political preferences

vote choice

turnout

randomization

homogenous groups at the baseline

non-random self-selection into the treatment

non-perfect compliance

instrumental variable approach

local average treatment effects

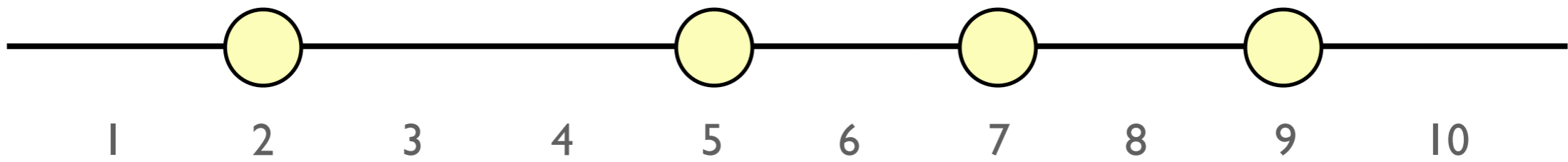



younger than 30



younger than 30



younger than 30



older than 30

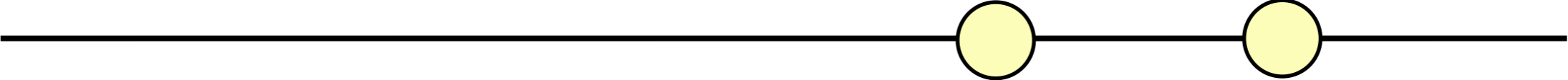

younger than 30



older than 30

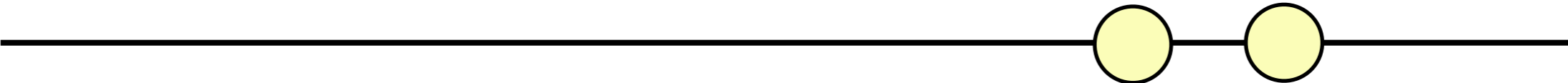

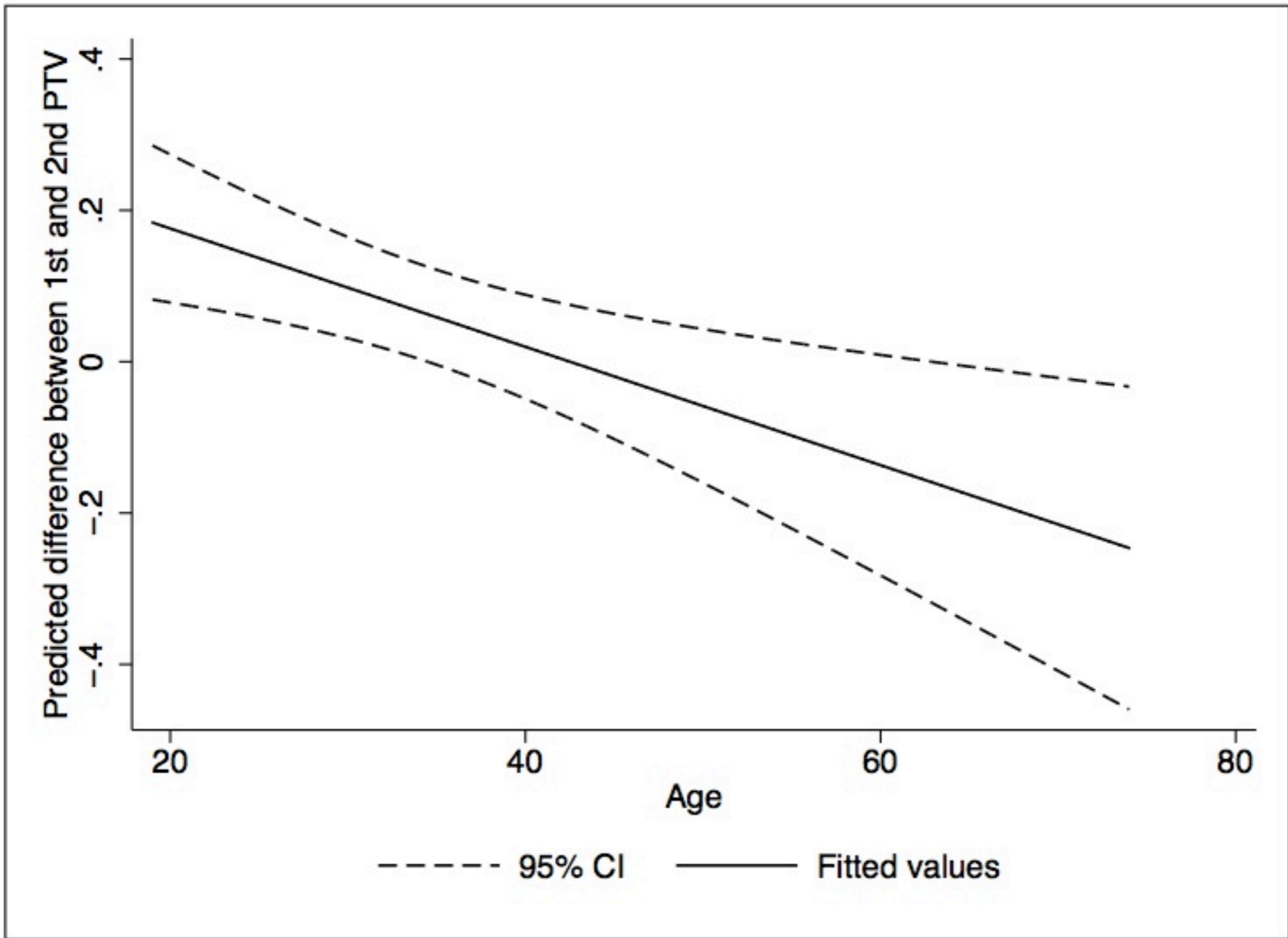

vote choice

{0 ; 1}



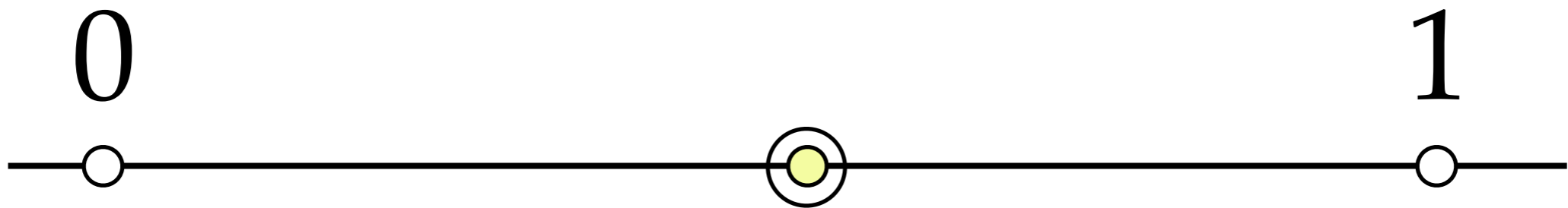

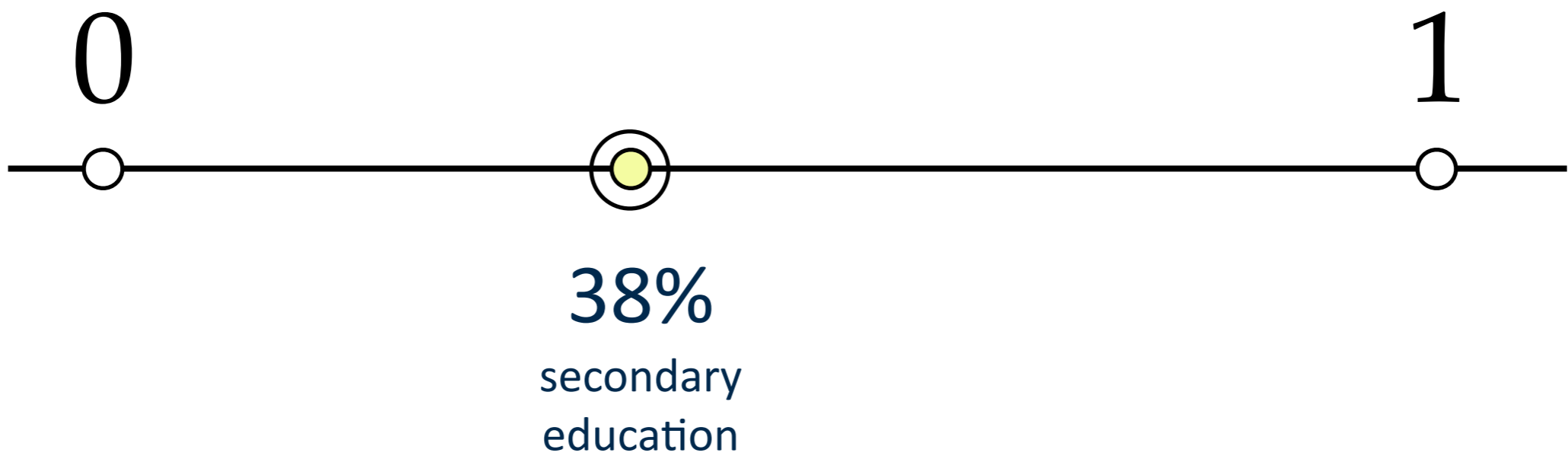

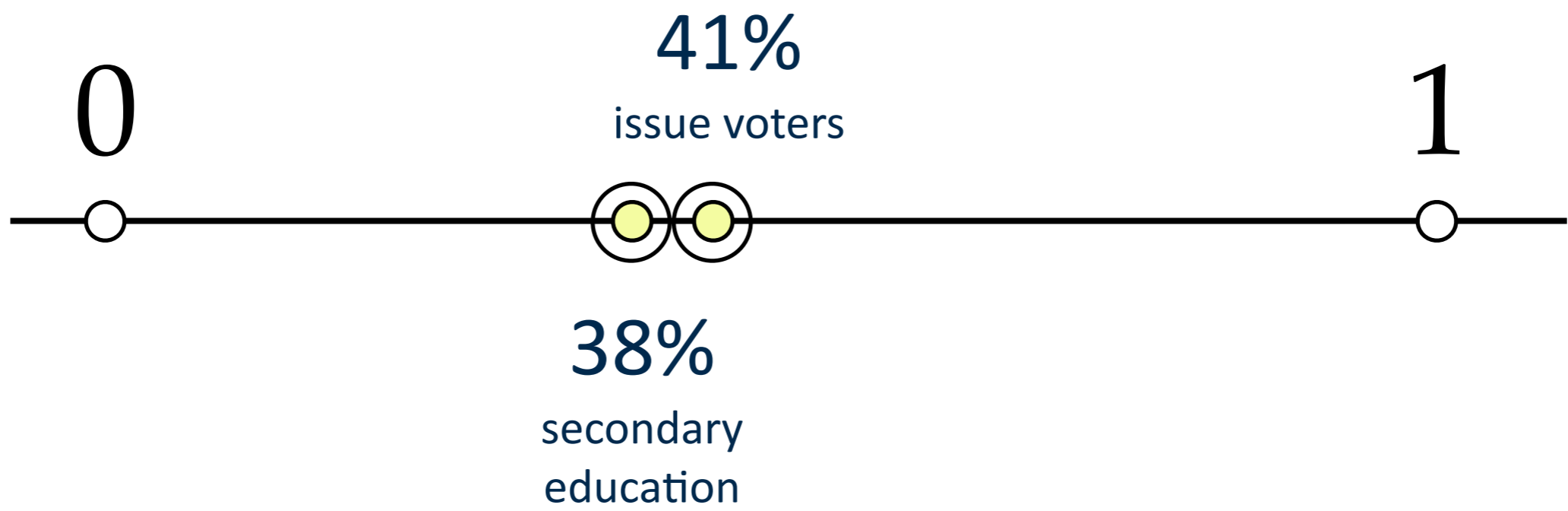

The causal effect on mobilization is virtually absent

Government and the Internet: Participation and Control

Government and the Internet: Participation and Control

Quantifying promises
enables control and accountability

Voting Advice Applications

Causal Effects of VAA usage on
political preferences, vote choice and turnout

Presentation in the workshop
'Government and the Internet: Participation and Control'

Kristjan Vassil
European University Institute

March 8, 2011
Florence